

# PowerTech™

## 6090SFM75 Diesel Engine

Propulsion Engine Specifications



### Dimensions

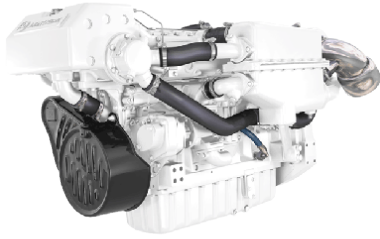

6090SFM75 shown

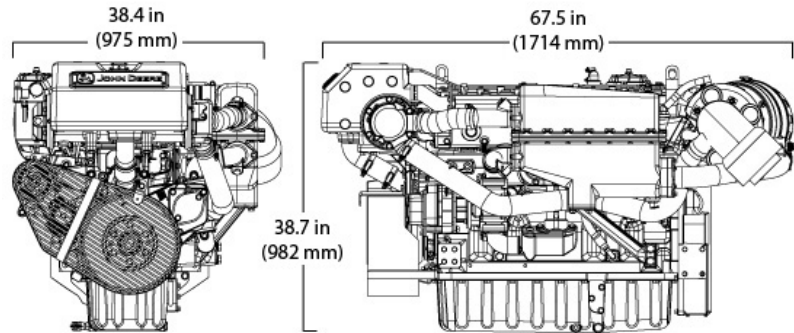

### Certifications

EPA Commercial Marine Tier 2  
IMO MARPOL Annex VI Compliant  
NRMM (97/68/EC)

### General data

Model	6090SFM75	Length - mm (in)	1714 (67.5)
Number of cylinders	6	Width - mm (in)	975 (38.4)
Displacement - L (cu in)	9.0 (549)	Height, Centerline to Top-- mm. (in)	662 (26.1)
Bore and Stroke-- mm (in)	118.4 x 136 (4.66 x 5.35)	Height, Centerline to Bottom-- mm. (in)	320 (12.6)
Compression Ratio	16.0 : 1	Weight, dry-- kg (lb)	1066 (2350)
Engine Type	In-line, 4- Cycle	Maximum Installed Angle	Front Up – degrees 12 Front Down – degrees 0
Aspiration	Air-to-sea water		

### Features and benefits

#### Watercooled Turbocharger and Exhaust Manifold

- Cooler and quieter environment for vessel and crew
- Reduced external connections eliminates hoses and fittings that can leak or break

#### Directed Top-liner Cooling

- Reduces upper liner temperature by as much as 100 degrees Fahrenheit (54 degrees Celsius)
- Durable and reliable power cylinder components

#### Replaceable Wet-type Cylinder Liners

- Hardened and precision machined for long life

#### Front or Side Service

- Oil and fuel filter combinations
- Application and service flexibility to provide installation convenience plus fast and easy maintenance

#### Heat Exchanger Cooled

- High-capacity heat exchanger designed for reliable operation in adverse conditions
- Seawater aftercooler for increased power and efficiency

#### High Torque and Low Rated RPM

- Excellent vessel control and maneuvering
- Lower rated rpm limits vibration and noise for better crew comfort

#### Fuel System

- Electronically controlled high pressure common rail fuel system provides precise fuel delivery with variable timing resulting in excellent fuel economy and performance
- Self diagnostics and protection

# Performance curve

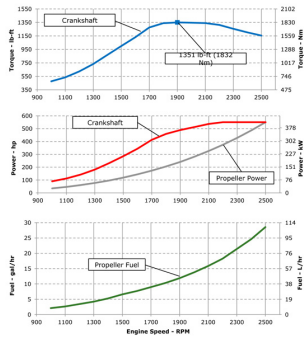
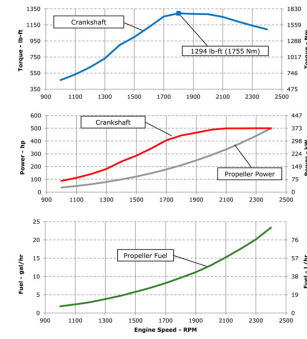
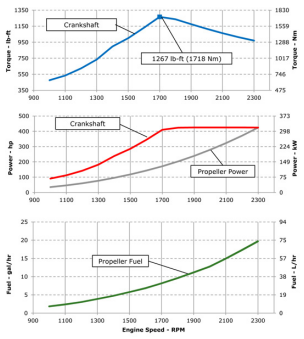
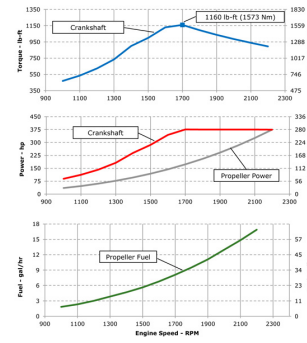
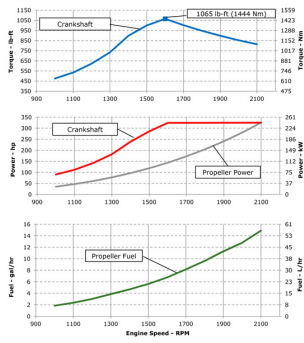

Performance data	M5	M4	M3	M2	M1
Rated Power - kW (hp)	410 (550)	373 (500)	317 (425)	280 (375)	242 (325)
Rated Speed - rpm	2500	2400	2300	2200	2100
Low Idle Speed - rpm	650	650	650	650	650
Peak Torque - Nm (ft-lb)	1832 (1351)	1755 (1294)	1718 (1267)	1573 (1160)	1444 (1065)
Peak Torque Speed - rpm	1900	1800	1700	1700	1600
Fuel Consumption - L/h (gal/hr)	108.0 (28.5)	94.0 (24.8)	80.4 (21.2)	70.9 (18.7)	62.7 (16.6)

M rating	M5	M4	M3	M2	M1
Typical load factor	< =35%	< =40%	< =50%	< =65%	> 65%
Typical annual usage (hr)	300-1,000 hr	1,000-3,000 hr	2,000-4,000 hr	3,000-5,000 hr	Unrestricted
Typical full-power operation (hr)	0.5 of each 8 hr	1 of each 12 hr	4 of each 12 hr	16 of each 24 hr	Uninterrupted

**John Deere Power Systems**  
 3801 W. Ridgeway Ave.  
 PO Box 5100  
 Waterloo, IA 50704-5100  
 Phone: 1-800-533-6446  
 Fax: 319.292.5075

**John Deere Power Systems**  
**Usine de Saran**  
 La Foulonnerie - B.P. 11.13  
 45401 Fleury les Aubrais Cedex  
 France  
 Phone: 33.2.38.82.61.19  
 Fax: 33.2.38.82.60.00

*Preliminary Information*  
 All values at rated speed and power with standard options unless otherwise noted.  
 Specifications and design subject to change without notice.